

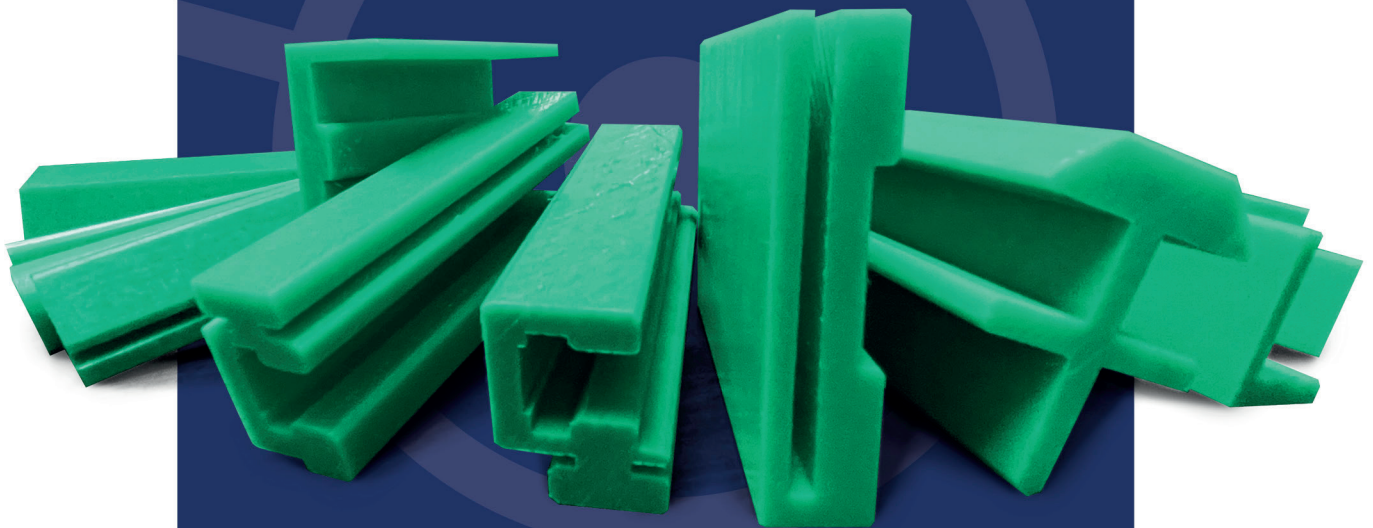

**DEMS**

**CHAIN GUIDES & PROFILE  
CATALOGUE**

DEMS Gartech is a specialist manufacturer of Ultra High Molecular Weight Polyethylene (UHMWPE) Roller Chain Guides, Profiles and wear strips. UHMWPE chain guides extend chain life, reduce noise, friction and ultimately reduces power consumption.



Available in all standard profiles or custom made to your specification.



# DEMS

## PROFILE - T single

## CHAIN GUIDES FOR SINGLE ROLLER CHAINS TO DIN 8187

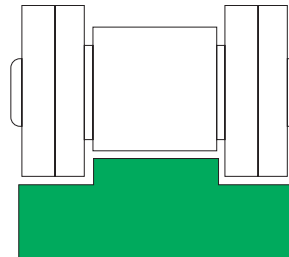
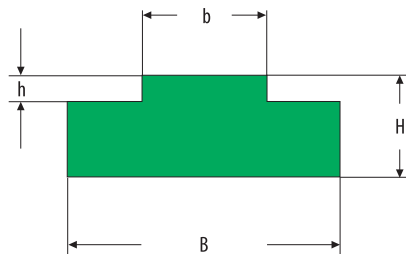

Art. No.	ISO-No.	Dimensions mm					kg/m
		Chain	B	H	b	h	
DG 1451 T 10110		$\frac{3}{8} \times \frac{5}{32}$ "	15	10	3,8	1,5	0,125
DG 1451 T 10210	06 B-1	$\frac{3}{8} \times \frac{7}{32}$ "	15	10	5,5	1,5	0,125
DG 1451 T 10310	083	$\frac{1}{2} \times \frac{3}{16}$ "	15	10	4,7	1,6	0,125
DG 1451 T 10410	085	$\frac{1}{2} \times \frac{1}{4}$ "	20	10	6,2	2,1	0,160
DG 1451 T 10510	08 B-1	$\frac{1}{2} \times \frac{5}{16}$ "	20	10	7,5	2,2	0,160
DG 1451 T 10515	08 B-1	$\frac{1}{2} \times \frac{5}{16}$ "	20	15	7,5	2,2	0,254
DG 1451 T 10520	08 B-1	$\frac{1}{2} \times \frac{5}{16}$ "	20	20	7,5	2,2	0,349
DG 1451 T 10530	08 B-1	$\frac{1}{2} \times \frac{5}{16}$ "	20	30	7,5	2,2	0,534
DG 1451 T 10610		$\frac{5}{8} \times \frac{1}{4}$ "	20	10	6,3	2,6	0,155
DG 1451 T 10710	10 B-1	$\frac{5}{8} \times \frac{3}{8}$ "	20	10	9,3	2,6	0,155
DG 1451 T 10715	10 B-1	$\frac{5}{8} \times \frac{3}{8}$ "	20	15	9,3	2,6	0,250
DG 1451 T 10720	10 B-1	$\frac{5}{8} \times \frac{3}{8}$ "	20	20	9,3	2,6	0,349
DG 1451 T 10730	10 B-1	$\frac{5}{8} \times \frac{3}{8}$ "	20	30	9,3	2,6	0,541
DG 1451 T 10810	12 B-1	$\frac{3}{4} \times \frac{7}{16}$ "	25	10	11,3	2,4	0,205
DG 1451 T 10815	12 B-1	$\frac{3}{4} \times \frac{7}{16}$ "	25	15	11,3	2,4	0,319
DG 1451 T 10820	12 B-1	$\frac{3}{4} \times \frac{7}{16}$ "	25	20	11,3	2,4	0,434
DG 1451 T 10830	12 B-1	$\frac{3}{4} \times \frac{7}{16}$ "	25	30	11,3	2,4	0,676
DG 1451 T 10915	16 B-1	1" x 17 mm	40	15	16,5	3,5	0,484
DG 1451 T 10920	16 B-1	1" x 17 mm	40	20	16,5	3,5	0,674
DG 1451 T 10930	16 B-1	1" x 17 mm	40	30	16,5	3,5	1,038
DG 1451 T 11015	20 B-1	$1\frac{1}{4} \times \frac{3}{4}$ "	45	15	19,0	4,2	0,504
DG 1451 T 11115	24 B-1	$1\frac{1}{2} \times 1$ "	60	15	24,7	5,5	0,664
DG 1451 T 11220	28 B-1	$1\frac{3}{4} \times 31$ mm	75	20	30,1	6,8	1,123
DG 1451 T 11320	32 B-1	2" x 31 mm	80	20	30,1	7,7	1,133



2 Teakfield Road, Springfield Park,  
Durban, South Africa

Tel: (+27) 31 579 9300  
Email: [admin@dems.co.za](mailto:admin@dems.co.za)  
Website: [www.dems.co.za](http://www.dems.co.za)



Osborn Park, Stark Road, Germiston,  
Johannesburg, South Africa

Tel: (+27) 11 824 0834  
Email: [admin@dems.co.za](mailto:admin@dems.co.za)  
Website: [www.dems.co.za](http://www.dems.co.za)



11 Falcon Crescent, Airport City,  
Cape Town, South Africa

Tel: (+27) 21 534 3388  
Email: [info@gartech.co.za](mailto:info@gartech.co.za)  
Website: [www.gartech.co.za](http://www.gartech.co.za)



## PROFILE - T twin

## CHAIN GUIDES FOR TWIN ROLLER CHAINS TO DIN 8187

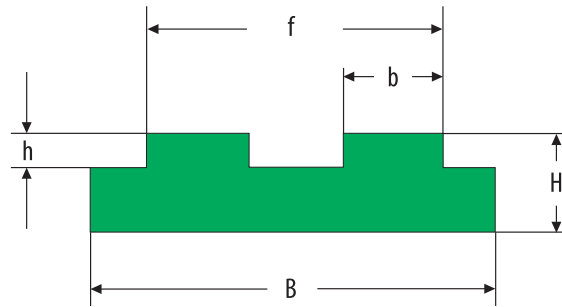

Art. No.	ISO-No.	Dimensions mm						kg/m
		Chain	B	H	b	h	f	
DG 1451 T 201	06 B-2	$\frac{3}{8} \times \frac{7}{32}$ "	25,0	10	5,5	1,5	15,7	0,212
DG 1451 T 202	08 B-2	$\frac{1}{2} \times \frac{5}{16}$ "	35,0	10	7,5	2,2	21,4	0,287
DG 1451 T 203	08 B-2	$\frac{1}{2} \times \frac{5}{16}$ "	35,0	15	7,5	2,2	21,4	0,910
DG 1451 T 204	08 B-2	$\frac{1}{2} \times \frac{5}{16}$ "	35,0	20	7,5	2,2	21,4	0,616
DG 1451 T 205	08 B-2	$\frac{1}{2} \times \frac{5}{16}$ "	35,0	30	7,5	2,2	21,4	0,945
DG 1451 T 206	10 B-2	$\frac{5}{8} \times \frac{3}{8}$ "	40,0	10	9,3	2,6	25,9	0,327
DG 1451 T 207	12 B-2	$\frac{3}{4} \times \frac{7}{16}$ "	45,0	10	11,3	2,4	30,8	0,374
DG 1451 T 208	16 B-2	1" x 17 mm	48,4	15	16,5	3,5	48,4	0,629
DG 1451 T 209	20 B-2	$1\frac{1}{4} \times \frac{3}{4}$ "	55,5	15	19,0	4,2	55,5	0,724
DG 1451 T 210	24 B-2	$1\frac{1}{2} \times 1$ "	73,1	20	24,7	5,5	73,1	1,248
DG 1451 T 211	28 B-2	$1\frac{3}{4} \times 31$ mm	89,7	25	30,1	6,8	89,7	1,921
DG 1451 T 212	32 B-2	2" x 31 mm	88,7	30	30,1	7,7	88,7	2,310



2 Teakfield Road, Springfield Park,  
Durban, South Africa

Tel: (+27) 31 579 9300  
Email: [admin@dems.co.za](mailto:admin@dems.co.za)  
Website: [www.dems.co.za](http://www.dems.co.za)



Osborn Park, Stark Road, Germiston,  
Johannesburg, South Africa

Tel: (+27) 11 824 0834  
Email: [admin@dems.co.za](mailto:admin@dems.co.za)  
Website: [www.dems.co.za](http://www.dems.co.za)



11 Falcon Crescent, Airport City,  
Cape Town, South Africa

Tel: (+27) 21 534 3388  
Email: [info@gartech.co.za](mailto:info@gartech.co.za)  
Website: [www.gartech.co.za](http://www.gartech.co.za)



## PROFILE - T triple

## CHAIN GUIDES FOR TRIPLE ROLLER CHAINS TO DIN 8187

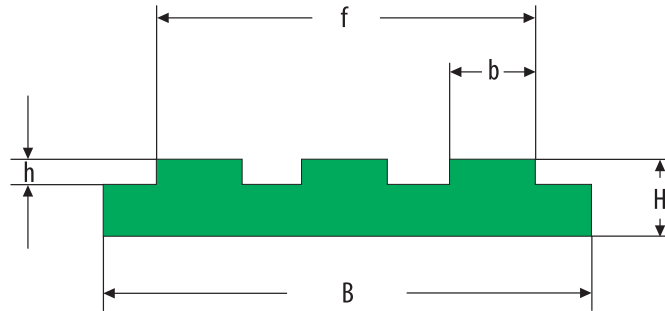

Art. No.	ISO-No.	Dimensions mm						kg/m
		Chain	B	H	b	h	f	
DG 1451 T 301	06 B-3	$\frac{3}{8} \times \frac{7}{32}$ "	35,0	10	5,5	1,5	25,9	0,304
DG 1451 T 302	08 B-3	$\frac{1}{2} \times \frac{5}{16}$ "	45,0	10	7,5	2,2	35,3	0,374
DG 1451 T 303	08 B-3	$\frac{1}{2} \times \frac{5}{16}$ "	45,0	15	7,5	2,2	35,3	0,589
DG 1451 T 304	08 B-3	$\frac{1}{2} \times \frac{5}{16}$ "	45,0	20	7,5	2,2	35,3	0,803
DG 1451 T 305	08 B-3	$\frac{1}{2} \times \frac{5}{16}$ "	45,0	30	7,5	2,2	35,3	1,228
DG 1451 T 306	10 B-3	$\frac{5}{8} \times \frac{3}{8}$ "	55,0	10	9,3	2,6	42,5	0,452
DG 1451 T 307	12 B-3	$\frac{3}{4} \times \frac{7}{16}$ "	65,0	10	11,3	2,4	50,3	0,574
DG 1451 T 308	16 B-3	1" x 17 mm	95,0	15	16,5	3,5	80,3	1,168
DG 1451 T 309	20 B-3	$1\frac{1}{4} \times \frac{3}{4}$ "	105,0	15	19,0	4,2	92,0	1,300
DG 1451 T 310	24 B-3	$1\frac{1}{2} \times 1$ "	135,0	20	24,7	5,5	121,5	2,247
DG 1451 T 311		$1\frac{3}{4} \times 31$ mm	170,0	25	30,1	6,8	149,3	3,522
DG 1451 T 312	32 B-3	2" x 31 mm	170,0	30	30,1	7,7	149,3	4,262



2 Teakfield Road, Springfield Park,  
Durban, South Africa

Tel: (+27) 31 579 9300  
Email: [admin@dems.co.za](mailto:admin@dems.co.za)  
Website: [www.dems.co.za](http://www.dems.co.za)



Osborn Park, Stark Road, Germiston,  
Johannesburg, South Africa

Tel: (+27) 11 824 0834  
Email: [admin@dems.co.za](mailto:admin@dems.co.za)  
Website: [www.dems.co.za](http://www.dems.co.za)



11 Falcon Crescent, Airport City,  
Cape Town, South Africa

Tel: (+27) 21 534 3388  
Email: [info@gartech.co.za](mailto:info@gartech.co.za)  
Website: [www.gartech.co.za](http://www.gartech.co.za)



# DEMS

## PROFILE - K

## CHAIN GUIDES FOR SINGLE ROLLER CHAINS TO DIN 8187

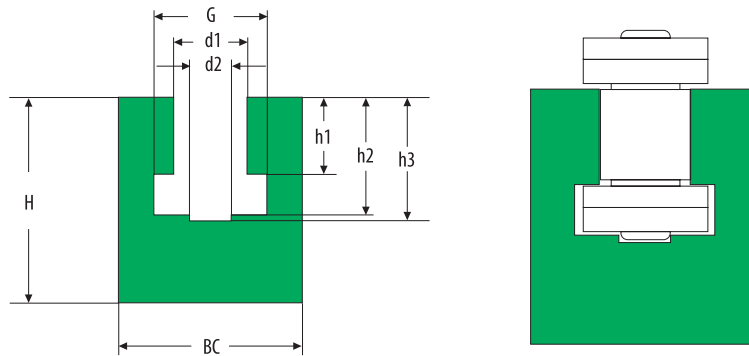

Art. No.	ISO-No.	Dimensions mm									kg/m
		Chain	B	H	h1	h2	h3	d2	d1	G	
DG 1451 K 101		$\frac{3}{8} \times \frac{5}{32}$ "	20	25	3,8	6,8	9,0	4	6,6	9,3	0,419
DG 1451 K 102	06 B-1	$\frac{3}{8} \times \frac{7}{32}$ "	20	25	5,5	8,7	9,9	4	6,6	9,3	0,404
DG 1451 K 103	083	$\frac{1}{2} \times \frac{3}{16}$ "	20	25	4,3	7,4	8,3	4	8,0	10,8	0,397
DG 1451 K 104	085	$\frac{1}{2} \times \frac{1}{4}$ "	24	30	6,3	9,8	11,2	5	8,0	11,8	0,586
DG 1451 K 105	085	$\frac{1}{2} \times \frac{1}{4}$ "	24	30	6,3	10,2	11,3	5	8,7	12,8	0,576
DG 1451 K 106	08 B-1	$\frac{1}{2} \times \frac{5}{16}$ "	24	30	7,5	11,5	12,7	5	8,7	12,8	0,564
DG 1451 K 107		$\frac{5}{8} \times \frac{1}{4}$ "	30	30	6,3	10,3	11,7	6	10,4	15,4	0,719
DG 1451 K 108	10 B-1	$\frac{5}{8} \times \frac{3}{8}$ "	30	35	9,3	13,5	14,8	6	10,4	15,4	0,831
DG 1451 K 109	12 B-1	$\frac{3}{4} \times \frac{7}{16}$ "	40	35	11,3	15,9	17,5	7,9	12,3	16,9	1,103
DG 1451 K 110		1" x 17 mm	40	45	16,5	25,7	27,0	9	16,1	24,4	1,270
DG 1451 K 111	20 B-1	$1\frac{1}{4} \times \frac{3}{4}$ "	50	50	19,0	30,0	32,0	11	19,3	27,5	1,712
DG 1451 K 112	24 B-1	$1\frac{1}{2} \times 1$ "	60	60	25,2	38,2	40,1	16	25,7	36,5	2,490
DG 1451 K 113	28 B-1	$1\frac{3}{4} \times 31$ mm	60	70	30,1	46,9	48,9	17	28,3	41,5	2,473
DG 1451 K 114	32 B-1	2" x 31 mm	70	75	30,1	47,3	53,0	19	29,6	44,5	3,264



2 Teakfield Road, Springfield Park,  
Durban, South Africa

Tel: (+27) 31 579 9300  
Email: [admin@dems.co.za](mailto:admin@dems.co.za)  
Website: [www.dems.co.za](http://www.dems.co.za)



Osborn Park, Stark Road, Germiston,  
Johannesburg, South Africa

Tel: (+27) 11 824 0834  
Email: [admin@dems.co.za](mailto:admin@dems.co.za)  
Website: [www.dems.co.za](http://www.dems.co.za)



11 Falcon Crescent, Airport City,  
Cape Town, South Africa

Tel: (+27) 21 534 3388  
Email: [info@gartech.co.za](mailto:info@gartech.co.za)  
Website: [www.gartech.co.za](http://www.gartech.co.za)



## PROFILE - U

## CHAIN GUIDES FOR SINGLE ROLLER CHAINS TO DIN 8187

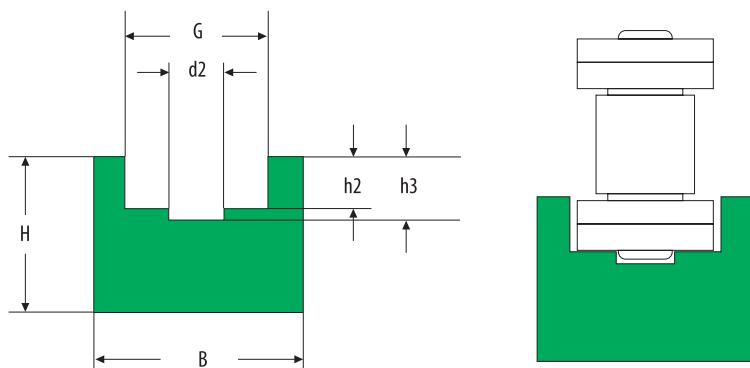

Art. No.	ISO-No.	Dimensions mm							kg/m
		Chain	B	H	h2	h3	d2	G	
DG 1451 U 101		$\frac{3}{8} \times \frac{5}{32}$ "	20	15	2,7	4,0	3,7	9,2	0,262
DG 1451 U 102	06 B-1	$\frac{3}{8} \times \frac{7}{32}$ "	20	15	2,8	4,2	3,7	9,2	0,262
DG 1451 U 103	083	$\frac{1}{2} \times \frac{3}{16}$ "	20	15	2,3	3,4	4,0	10,7	0,254
DG 1451 U 104	085	$\frac{1}{2} \times \frac{1}{4}$ "	20	15	3,2	4,7	4,4	11,7	0,242
DG 1451 U 105	085	$\frac{1}{2} \times \frac{1}{4}$ "	25	15	3,5	4,8	4,9	12,7	0,307
DG 1451 U 106	08 B-1	$\frac{1}{2} \times \frac{5}{16}$ "	25	15	3,5	4,8	4,9	12,7	0,307
DG 1451 U 107		$\frac{5}{8} \times \frac{1}{4}$ "	25	15	3,6	5,2	5,5	15,2	0,294
DG 1451 U 108	10 B-1	$\frac{5}{8} \times \frac{3}{8}$ "	25	15	3,6	5,1	5,5	15,2	0,294
DG 1451 U 109	12 B-1	$\frac{3}{4} \times \frac{7}{16}$ "	25	20	3,9	5,7	6,2	16,7	0,402
DG 1451 U 110	16 B-1	1" x 17 mm	35	25	8,4	9,9	8,9	24,4	0,609



2 Teakfield Road, Springfield Park,  
Durban, South Africa

Tel: (+27) 31 579 9300  
Email: [admin@demco.co.za](mailto:admin@demco.co.za)  
Website: [www.demco.co.za](http://www.demco.co.za)



Osborn Park, Stark Road, Germiston,  
Johannesburg, South Africa

Tel: (+27) 11 824 0834  
Email: [admin@demco.co.za](mailto:admin@demco.co.za)  
Website: [www.demco.co.za](http://www.demco.co.za)



11 Falcon Crescent, Airport City,  
Cape Town, South Africa

Tel: (+27) 21 534 3388  
Email: [info@gartech.co.za](mailto:info@gartech.co.za)  
Website: [www.gartech.co.za](http://www.gartech.co.za)



## PROFILE - NTG

## CHAIN GUIDES FOR SINGLE ROLLER CHAINS TO DIN 8187

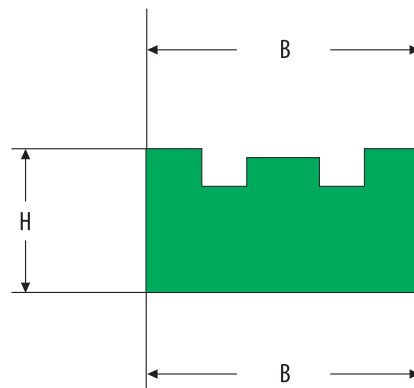

Art. No.	ISO-No.	Dimensions mm			kg/m
		Chain	B	H	
DG 1451 NTG 01	06 B -1	$\frac{3}{8} \times \frac{7}{32}$ "	20	10	0,160
DG 1451 NTG 02	083 -1	$\frac{1}{2} \times \frac{3}{16}$ "	20	10	0,188
DG 1451 NTG 03	085 -1	$\frac{1}{2} \times \frac{1}{4}$ "	22	10	0,207
DG 1451 NTG 04	08 B -1	$\frac{1}{2} \times \frac{5}{16}$ "	25	15	0,312
DG 1451 NTG 05		$\frac{5}{8} \times \frac{1}{4}$ "	25	15	0,352
DG 1451 NTG 06	10 B -1	$\frac{5}{8} \times \frac{3}{8}$ "	28	15	0,334
DG 1451 NTG 07	12 B -1	$\frac{3}{4} \times \frac{7}{16}$ "	30	20	0,467
DG 1451 NTG 08	16 B -1	1" x 17 mm	42	25	0,830
DG 1451 NTG 09	20 B -1	$1\frac{1}{4} \times \frac{3}{4}$ "	50	25	0,933



2 Teakfield Road, Springfield Park,  
Durban, South Africa

Tel: (+27) 31 579 9300  
Email: [admin@dem.s.co.za](mailto:admin@dem.s.co.za)  
Website: [www.dem.s.co.za](http://www.dem.s.co.za)



Osborn Park, Stark Road, Germiston,  
Johannesburg, South Africa

Tel: (+27) 11 824 0834  
Email: [admin@dem.s.co.za](mailto:admin@dem.s.co.za)  
Website: [www.dem.s.co.za](http://www.dem.s.co.za)



11 Falcon Crescent, Airport City,  
Cape Town, South Africa

Tel: (+27) 21 534 3388  
Email: [info@gartech.co.za](mailto:info@gartech.co.za)  
Website: [www.gartech.co.za](http://www.gartech.co.za)



# DEMS

PROFILE - CF

FLAT TOP PROFILE

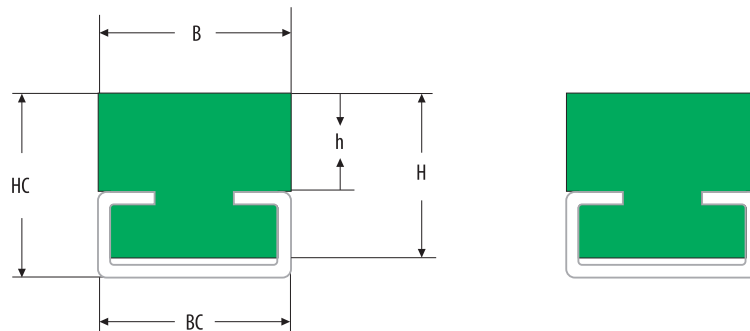

Art. No.	C-steel No.	Dimensions mm					kg/m
		BC	B	HC	H	h	
DG 1451 CF 0101	C 01	24	20	6	4	0,8	0,075
DG 1451 CF 0201	C 01	24	20	11	9	5,8	0,185
DG 1451 CF 0102	C 02	20	20	11	6	1,0	0,085
DG 1451 CF 0202	C 02	20	20	16	10	6,0	0,165
DG 1451 CF 0302	C 02	20	20	14	10	4,0	0,157
DG 1451 CF 0402	C 02	20	20	17	15	7,0	0,245
DG 1451 CF 0502	C 02	20	20	20	18	10,0	0,302
DG 1451 CF 0603	C 03	28	28	15	10	3,0	0,210
DG 1451 CF 0703	C 03	28	28	18	15	6,0	0,327
DG 1451 CF 0805	C 05	38	38	22	15	4,0	0,506
DG 1451 CF 0905	C 05	38	38	25	20	7,0	0,646
DG 1451 CF 1010	C 10	60	60	30	20	10,0	1,008

**DEMS**

2 Teakfield Road, Springfield Park,  
Durban, South Africa

Tel: (+27) 31 579 9300  
Email: [admin@dems.co.za](mailto:admin@dems.co.za)  
Website: [www.dems.co.za](http://www.dems.co.za)

**DEMS E.G.A.**

Osborn Park, Stark Road, Germiston,  
Johannesburg, South Africa

Tel: (+27) 11 824 0834  
Email: [admin@dems.co.za](mailto:admin@dems.co.za)  
Website: [www.dems.co.za](http://www.dems.co.za)

**DEMS Gartech**

11 Falcon Crescent, Airport City,  
Cape Town, South Africa

Tel: (+27) 21 534 3388  
Email: [info@gartech.co.za](mailto:info@gartech.co.za)  
Website: [www.gartech.co.za](http://www.gartech.co.za)



## PROFILE - HC

## CHAIN GUIDES FOR SINGLE ROLLER CHAINS TO DIN 8187

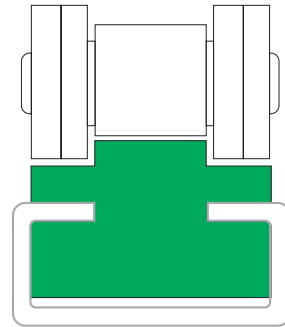
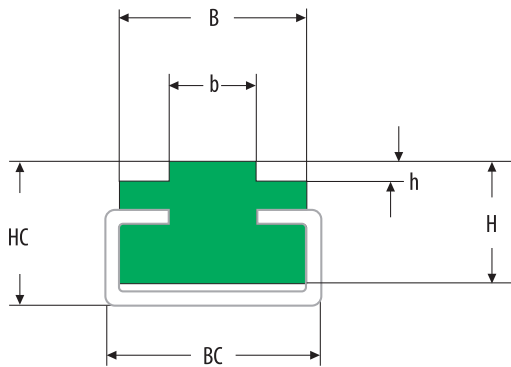

Art. No.	C-steel No.	ISO-No.	Dimensions mm							kg/m
			Chain	BC	B	b	HC	H	h	
DG 1451 CT 0401	CO 1	08 B-1	$1/2 \times 5/16''$	24	20,0	7,5	11	9	2,2	0,135
DG 1451 CT 0202	CO 2	085	$1/2 \times 1/4''$	20	20,0	6,2	17	15	2,1	0,217
DG 1451 CT 0402	CO 2	083	$1/2 \times 3/16''$	20	17,0	4,7	17	15	1,6	0,205
DG 1451 CT 0502	CO 2	085	$1/2 \times 1/4''$	20	17,0	6,2	17	15	2,1	0,197
DG 1451 CT 0602	CO 2	08 B-1	$1/2 \times 5/16''$	20	17,0	7,5	17	15	2,2	1,225
DG 1451 CT 0702	CO 2		$5/8 \times 1/4''$	20	17,0	6,3	17	15	2,6	0,410
DG 1451 CT 0802	CO 2	10 B-1	$5/8 \times 3/8''$	20	17,0	9,3	17	15	2,6	0,205
DG 1451 CT 0902	CO 2	12 B-1	$3/4 \times 7/16''$	20	20,0	11,3	17	15	2,4	0,222
DG 1451 CT 1003	CO 3	12 B-1	$3/4 \times 7/16''$	28	23,5	11,3	18	15	2,4	0,274
DG 1451 CT 1103	CO 3	16 B-1	1" x 17 mm	28	23,5	16,5	18	15	3,5	0,282
DG 1451 CT 1203	CO 3	20 B-1	$1 1/4 \times 3/4''$	28	28,0	19,0	18	15	4,3	0,590
DG 1451 CT 1305	CO 5	24 B-1	$1 1/2 \times 1''$	38	33,0	24,7	30	25	5,5	0,704
DG 1451 CT 1405	CO 5	28 B-1	$1 3/4 \times 31 \text{ mm}$	38	38,0	30,1	30	25	6,8	0,731
DG 1451 CT 1505	CO 5	32 B-1	2" x 31 mm	38	38,0	30,1	30	25	7,7	0,749
DG 1451 CT 1610	CO 6	32 B-1	2" x 31 mm	60	60,0	30,1	35	25	7,7	1,240



2 Teakfield Road, Springfield Park,  
Durban, South Africa

Tel: (+27) 31 579 9300  
Email: [admin@dem.s.co.za](mailto:admin@dem.s.co.za)  
Website: [www.dem.s.co.za](http://www.dem.s.co.za)



Osborn Park, Stark Road, Germiston,  
Johannesburg, South Africa

Tel: (+27) 11 824 0834  
Email: [admin@dem.s.co.za](mailto:admin@dem.s.co.za)  
Website: [www.dem.s.co.za](http://www.dem.s.co.za)



11 Falcon Crescent, Airport City,  
Cape Town, South Africa

Tel: (+27) 21 534 3388  
Email: [info@gartech.co.za](mailto:info@gartech.co.za)  
Website: [www.gartech.co.za](http://www.gartech.co.za)



## PROFILE - CDT

## CHAIN GUIDES FOR SINGLE ROLLER CHAINS TO DIN 8187

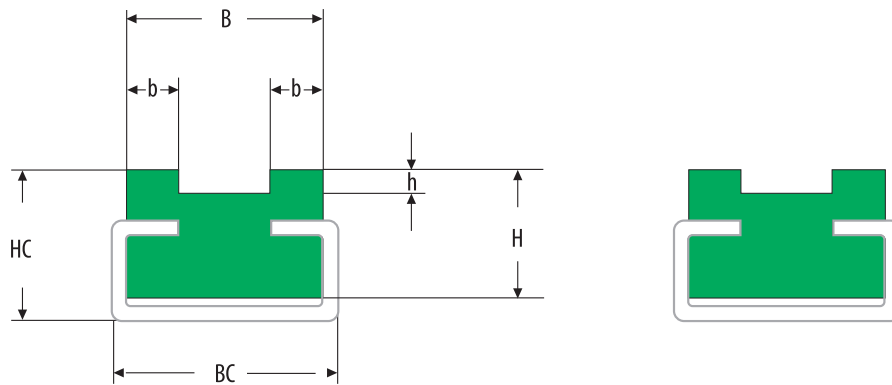

Art. No.	C-steel No.	ISO-No.	Dimensions mm							kg/m
			Chain	BC	B	b	HC	H	h	
DG 1451 CTD 0102	CO 2	08 B-2	$1/2 \times 5/16''$	20	21,4	7,5	17	15	2,2	0,237
DG 1451 CTD 0202	CO 2	10 B-2	$5/8 \times 3/8''$	20	25,7	9,3	17	15	2,6	0,267
DG 1451 CTD 0303	CO 3	12 B-2	$3/4 \times 7/16''$	28	30,7	11,3	20	15	2,4	0,342
DG 1451 CTD 0405	CO 5	16 B-2	1" x 17 mm	38	48,0	16,5	27	20	3,5	1,390
DG 1451 CTD 0505	CO 5	20 B-2	$1 1/4 \times 3/4''$	38	55,0	19,0	30	25	4,3	0,948
DG 1451 CTD 0605	CO 5	24 B-2	$1 1/2 \times 1''$	38	72,0	24,7	35	30	5,5	1,425

### DEMS

2 Teakfield Road, Springfield Park,  
Durban, South Africa

Tel: (+27) 31 579 9300  
Email: [admin@dems.co.za](mailto:admin@dems.co.za)  
Website: [www.dems.co.za](http://www.dems.co.za)

### DEMS E.G.A.

Osborn Park, Stark Road, Germiston,  
Johannesburg, South Africa

Tel: (+27) 11 824 0834  
Email: [admin@dems.co.za](mailto:admin@dems.co.za)  
Website: [www.dems.co.za](http://www.dems.co.za)

### DEMS Gartech

11 Falcon Crescent, Airport City,  
Cape Town, South Africa

Tel: (+27) 21 534 3388  
Email: [info@gartech.co.za](mailto:info@gartech.co.za)  
Website: [www.gartech.co.za](http://www.gartech.co.za)



# DEMS

## PROFILE - CU

## CHAIN GUIDES FOR SINGLE ROLLER CHAINS TO DIN 8187

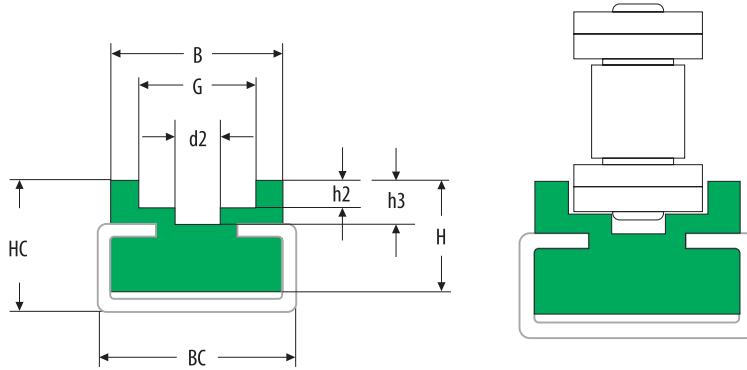

Art. No.	C-steel No.	ISO-No.	Dimensions mm									kg/m
			Chain	BC	B	H	HC	h2	h3	d2	G	
DG 1451 CU 0101	C 01	08 B-1	$\frac{1}{2} \times \frac{5}{16}$ "	24	20	9	11	3,5	4,8	4,9	12,7	0,112
DG 1451 CU 0203	C 03	10 B-1	$\frac{5}{8} \times \frac{3}{8}$ "	28	23	12	18	3,6	5,1	5,5	15,2	0,315
DG 1451 CU 0303	C 03	12 B-1	$\frac{3}{4} \times \frac{7}{16}$ "	28	23	12	18	3,9	5,7	6,2	16,7	0,165
DG 1451 CU 0408	C 08	16 B-1	1" x 17 mm	38	32,5	20	30	8,4	9,9	8,9	24,4	0,357
DG 1451 CU 0510	C 10	20 B-1	$1\frac{1}{4}$ " x $\frac{3}{4}$ "	60	60	25	35	10,0	11,9	11,0	28,0	0,973
DG 1451 CU 0610	C 10	24 B-1	$1\frac{1}{2}$ " x 1"	60	60	30	40	13,0	14,9	16,0	35,0	1,340
DG 1451 CU 0710	C 10	28 B-1	$1\frac{3}{4}$ " x 31 mm	60	65	40	45	16,0	18,0	17,0	39,0	1,840
DG 1451 CU 1210	C 10	32 B-1	2" x 31 mm	60	70	40	45	16,0	21,7	19,0	44,0	2,040



2 Teakfield Road, Springfield Park,  
Durban, South Africa

Tel: (+27) 31 579 9300  
Email: [admin@dem.s.co.za](mailto:admin@dem.s.co.za)  
Website: [www.dem.s.co.za](http://www.dem.s.co.za)



Osborn Park, Stark Road, Germiston,  
Johannesburg, South Africa

Tel: (+27) 11 824 0834  
Email: [admin@dem.s.co.za](mailto:admin@dem.s.co.za)  
Website: [www.dem.s.co.za](http://www.dem.s.co.za)



11 Falcon Crescent, Airport City,  
Cape Town, South Africa

Tel: (+27) 21 534 3388  
Email: [info@gartech.co.za](mailto:info@gartech.co.za)  
Website: [www.gartech.co.za](http://www.gartech.co.za)



# DEMS

## PROFILE - CK

## CHAIN GUIDES FOR SINGLE ROLLER CHAINS TO DIN 8187

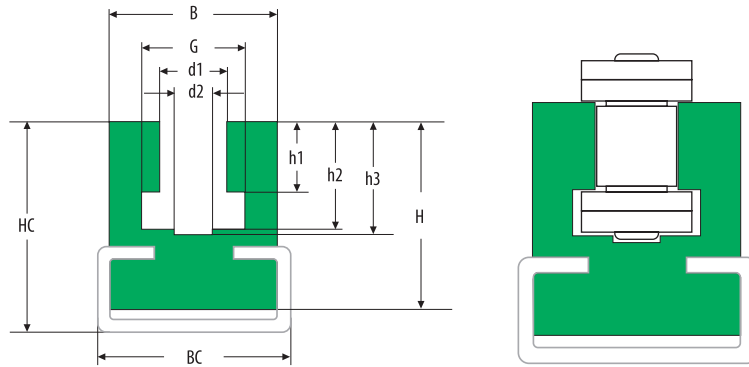

Art. No.	C-steel No.	ISO-No.	Dimensions mm											kg/m
			Chain	BC	B	H	HC	h1	h2	h3	d2	d1	G	
DG 1451 CK 102	C 02		$\frac{3}{8} \times \frac{5}{32}$ "	20	20	17,5	21	3,8	6,8	9,0	4	6,6	9,3	0,248
DG 1451 CK 202	C 02	06 B-1	$\frac{3}{8} \times \frac{7}{32}$ "	20	20	17,5	21	5,6	8,7	9,9	4	6,6	9,3	0,232
DG 1451 CK 302	C 02	083	$\frac{1}{2} \times \frac{3}{16}$ "	20	20	17,5	21	4,7	7,4	8,3	4	8,0	10,8	0,232
DG 1451 CK 403	C 03	085	$\frac{1}{2} \times \frac{1}{4}$ "	28	24	27,5	32	6,3	9,8	11,2	5	8,0	11,8	0,522
DG 1451 CK 503	C 03	085	$\frac{1}{2} \times \frac{1}{4}$ "	28	24	27,5	32	6,3	10,2	11,3	5	8,7	12,8	0,522
DG 1451 CK 603	C 03	08 B-1	$\frac{1}{2} \times \frac{5}{16}$ "	28	24	27,5	32	7,6	11,5	12,7	5	8,7	12,8	0,484
DG 1451 CK 703	C 03		$\frac{5}{8} \times \frac{1}{4}$ "	28	24	27,5	32	6,3	10,3	11,7	6	10,4	15,4	0,483
DG 1451 CK 803	C 03	10 B-1	$\frac{5}{8} \times \frac{3}{8}$ "	28	24	27,5	32	9,3	13,5	14,8	6	10,4	15,4	0,427
DG 1451 CK 905	C 05	12 B-1	$\frac{3}{4} \times \frac{7}{16}$ "	38	38	34,0	43	11,5	15,9	17,5	7,9	12,3	16,9	0,948
DG 1451 CK 1005	C 05	16 B-1	1" x 17 mm	38	38	40	50	16,5	25,7	27,0	9	16,1	24,4	0,903
DG 1451 CK 1110	C 10	20 B-1	$1\frac{1}{4} \times \frac{3}{4}$ "	60	60	45	55	19,0	30,0	32,0	11	19,3	27,5	2,640
DG 1451 CK 1210	C 10	24 B-1	$1\frac{1}{2} \times 1$ "	60	60	55	65	25,2	38,2	40,1	16	25,7	36,5	2,840
DG 1451 CK 1310	C 10	28 B-1	$1\frac{3}{4} \times 31$ mm	60	70	70	80	30,8	46,9	48,9	17	28,3	41,5	4,040
DG 1451 CK 1410	C 10	32 B-1	2" x 31 mm	60	70	70	80	30,8	47,3	53,0	19	29,6	44,5	4,040

**DEMS**

2 Teakfield Road, Springfield Park,  
Durban, South Africa

Tel: (+27) 31 579 9300  
Email: [admin@dem.s.co.za](mailto:admin@dem.s.co.za)  
Website: [www.dem.s.co.za](http://www.dem.s.co.za)

**DEMS E.G.A.**

Osborn Park, Stark Road, Germiston,  
Johannesburg, South Africa

Tel: (+27) 11 824 0834  
Email: [admin@dem.s.co.za](mailto:admin@dem.s.co.za)  
Website: [www.dem.s.co.za](http://www.dem.s.co.za)

**DEMS Gartech**

11 Falcon Crescent, Airport City,  
Cape Town, South Africa

Tel: (+27) 21 534 3388  
Email: [info@gartech.co.za](mailto:info@gartech.co.za)  
Website: [www.gartech.co.za](http://www.gartech.co.za)



# DEMS

PROFILE - ECT

CHAIN GUIDES FOR SINGLE ROLLER CHAINS TO DIN 8187

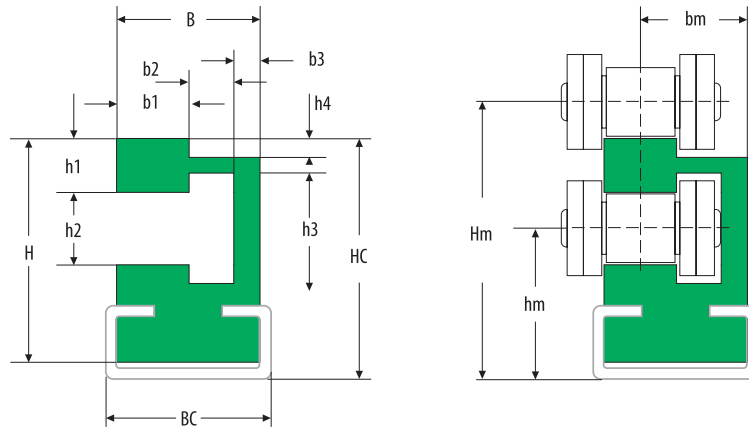

Art. No.	C-steel No.	ISO-No.	Dimensions mm														kg/m	
			Chain	BC	B	H	HC	h1	h2	h3	h4	b1	b2	b3	Hm	hm		bm
DG 1451 ECT 0102	C 02	06 B-1	$\frac{3}{8} \times \frac{7}{32}$ "	20	20,0	24	27	6,6	6,6	9,3	1,5	5,2	4,3	10,4	30,2	17	14,5	0,329
DG 1451 ECT 0202	C 02	08 B-1	$\frac{1}{2} \times \frac{5}{16}$ "	20	20,0	27	30	7,1	8,7	12,8	2,2	7,5	5,0	7,5	33,8	18	16,5	0,329
DG 1451 ECT 0302	C 02	10 B-1	$\frac{5}{8} \times \frac{3}{8}$ "	20	20,0	33	36	9,7	10,4	15,4	2,6	9,3	5,3	5,5	41,1	21	15,5	0,392
DG 1451 ECT 0403	C 03	12 B-1	$\frac{3}{4} \times \frac{7}{16}$ "	28	24,3	37	41	10,2	12,3	16,9	2,4	11,5	6,0	6,8	46,5	24	18,5	0,569
DG 1451 ECT 0503	C 03	16 B-1	1" x 17 mm	28	33,5	50	54	11,9	16,1	24,4	3,5	16,5	10,5	6,5	62,0	34	25,0	0,926

**DEMS**

2 Teakfield Road, Springfield Park,  
Durban, South Africa

Tel: (+27) 31 579 9300  
Email: [admin@dems.co.za](mailto:admin@dems.co.za)  
Website: [www.dems.co.za](http://www.dems.co.za)

**DEMS E.G.A.**

Osborn Park, Stark Road, Germiston,  
Johannesburg, South Africa

Tel: (+27) 11 824 0834  
Email: [admin@dems.co.za](mailto:admin@dems.co.za)  
Website: [www.dems.co.za](http://www.dems.co.za)

**DEMS Gartech**

11 Falcon Crescent, Airport City,  
Cape Town, South Africa

Tel: (+27) 21 534 3388  
Email: [info@gartech.co.za](mailto:info@gartech.co.za)  
Website: [www.gartech.co.za](http://www.gartech.co.za)



## PROFILE - CGK

## CHAIN GUIDES FOR SINGLE ROLLER CHAINS TO DIN 8187

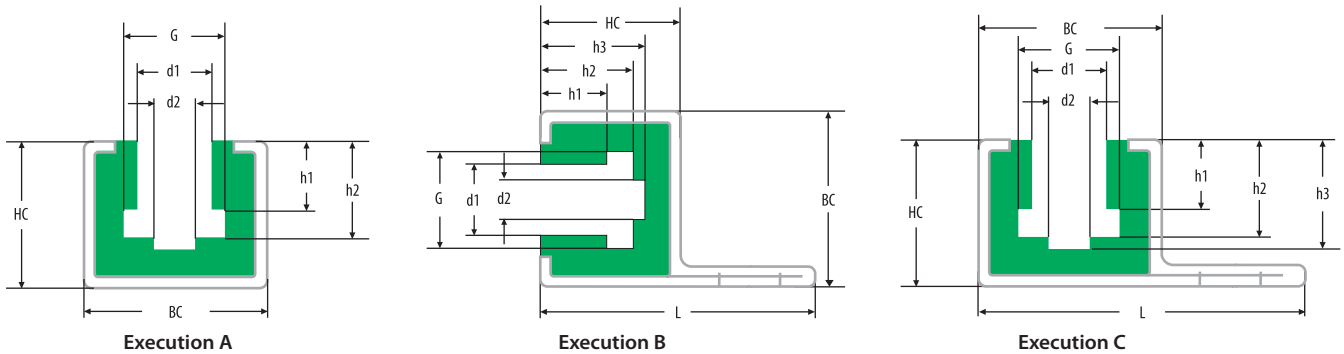

**Execution A** - Suitable for galvanized or stainless steel channel.

Art. No.	C-steel No.	ISO-No.	Dimensions mm									kg/m
			Chain	HC	BC	h1	h2	h3	d2	d1	G	
DG 1451 CGK 01	C 06	06 B-1	$\frac{3}{8} \times \frac{7}{32}$ "	24	30	5,6	8,7	9,9	4	6,6	9,3	0,477
DG 1451 CGK 02	C 06	083	$\frac{1}{2} \times \frac{3}{16}$ "	24	30	4,7	7,4	8,3	4	8,0	10,8	0,469
DG 1451 CGK 03	C 06	085	$\frac{1}{2} \times \frac{1}{4}$ "	24	30	6,3	9,8	11,2	5	8,0	11,8	0,454
DG 1451 CGK 04	C 06	085	$\frac{1}{2} \times \frac{1}{4}$ "	24	30	6,3	10,2	11,3	5	8,7	12,8	0,442
DG 1451 CGK 05	C 06	08 B-1	$\frac{1}{2} \times \frac{5}{16}$ "	24	30	7,6	11,5	12,7	5	8,7	12,8	0,437
DG 1451 CGK 06	C 06		$\frac{5}{8} \times \frac{1}{4}$ "	24	30	6,3	10,3	11,7	6	10,4	15,4	0,422
DG 1451 CGK 07	C 06	10 B-1	$\frac{5}{8} \times \frac{3}{8}$ "	24	30	9,3	13,5	14,8	6	10,4	15,4	0,384
DG 1451 CGK 08	C 06	12 B-1	$\frac{3}{4} \times \frac{7}{16}$ "	24	30	11,3	15,9	17,5	7,9	12,3	16,9	0,337
DG 1451 CGK 09	C 09	16 B-1	1" x 17 mm	40	45	16,5	25,7	27,0	9	16,1	24,4	0,953
DG 1451 CGK 10	C 09	20 B-1	$1\frac{1}{4} \times \frac{3}{4}$ "	40	45	19,0	30,0	32,0	11	19,3	27,5	0,753

**Execution B** - Suitable for galvanized or stainless steel channel. For horizontal fixing.

Art. No.	C-steel No.	ISO-No.	Dimensions mm										kg/m
			Chain	HC	BC	L	h1	h2	h3	d2	d1	G	
DG 1451 CGK 01	C 14	06 B-1	$\frac{3}{8} \times \frac{7}{32}$ "	25	31	47	5,6	8,7	9,9	4	6,6	9,3	0,95
DG 1451 CGK 02	C 14	083	$\frac{1}{2} \times \frac{3}{16}$ "	25	31	47	4,7	7,4	8,3	4	8,0	10,8	0,95
DG 1451 CGK 03	C 14	085	$\frac{1}{2} \times \frac{1}{4}$ "	25	31	47	6,3	9,8	11,2	5	8,0	11,8	0,95
DG 1451 CGK 04	C 14	085	$\frac{1}{2} \times \frac{1}{4}$ "	25	31	47	6,3	10,2	11,3	5	8,7	12,8	0,95
DG 1451 CGK 05	C 14	08 B-1	$\frac{1}{2} \times \frac{5}{16}$ "	25	31	47	7,6	11,5	12,7	5	8,7	12,8	0,95
DG 1451 CGK 06	C 14		$\frac{5}{8} \times \frac{1}{4}$ "	25	31	47	6,3	10,3	11,7	6	10,4	15,4	0,90
DG 1451 CGK 07	C 14	10 B-1	$\frac{5}{8} \times \frac{3}{8}$ "	25	31	47	9,3	13,5	14,8	6	10,4	15,4	0,90
DG 1451 CGK 08	C 14	12 B-1	$\frac{3}{4} \times \frac{7}{16}$ "	25	31	47	11,3	15,9	17,5	7,9	12,3	16,9	0,84

**Execution C** - Suitable for galvanized or stainless steel channel. For vertical fixing.

Art. No.	C-steel No.	ISO-No.	Dimensions mm										kg/m
			Chain	HC	BC	L	h1	h2	h3	d2	d1	G	
DG 1451 CGK 01	C 15	06 B-1	$\frac{3}{8} \times \frac{7}{32}$ "	25	31	53	5,6	8,7	9,9	4	6,6	9,3	1,14
DG 1451 CGK 02	C 15	083	$\frac{1}{2} \times \frac{3}{16}$ "	25	31	53	4,7	7,4	8,3	4	8,0	10,8	1,10
DG 1451 CGK 03	C 15	085	$\frac{1}{2} \times \frac{1}{4}$ "	25	31	53	6,3	9,8	11,2	5	8,0	11,8	1,10
DG 1451 CGK 04	C 15	085	$\frac{1}{2} \times \frac{1}{4}$ "	25	31	53	6,3	10,2	11,3	5	8,7	12,8	1,10
DG 1451 CGK 05	C 15	08 B-1	$\frac{1}{2} \times \frac{5}{16}$ "	25	31	53	7,6	11,5	12,7	5	8,7	12,8	1,10
DG 1451 CGK 06	C 15		$\frac{5}{8} \times \frac{1}{4}$ "	25	31	53	6,3	10,3	11,7	6	10,4	15,4	1,05
DG 1451 CGK 07	C 15	10 B-1	$\frac{5}{8} \times \frac{3}{8}$ "	25	31	53	9,3	13,5	14,8	6	10,4	15,4	1,05
DG 1451 CGK 08	C 15	12 B-1	$\frac{3}{4} \times \frac{7}{16}$ "	25	31	53	11,3	15,9	17,5	7,9	12,3	16,9	1,05



PROFILE - RK

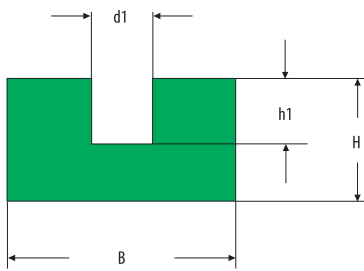

PROFILE - CKR

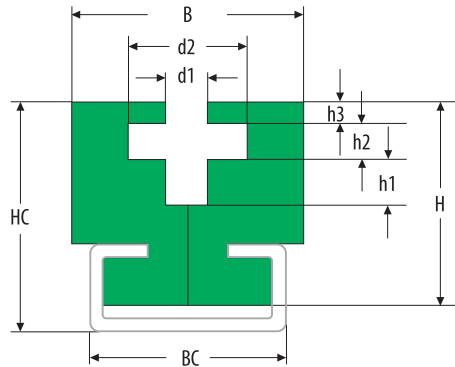

PROFILE - CKRS

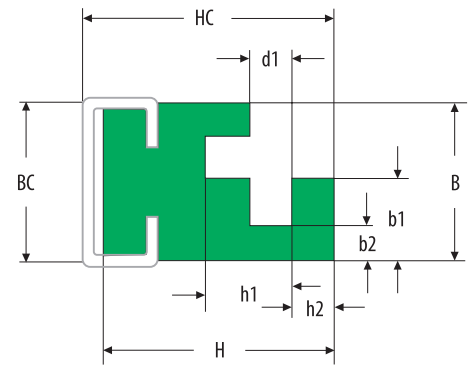

Art. No.	C-steel No.	Dimensions mm											kg/m	
		BC	B	H	HG	d1	d2	h1	h2	h3	b1	b2		
DG 1451 RK 06			30,0	15	-	7	-	8	-	-	-	-	-	0,374
DG 1451 RK 08			35,0	20	-	9	-	10	-	-	-	-	-	0,574
DG 1451 RK 10			45,0	25	-	11	-	12	-	-	-	-	-	0,928
DG 1451 RK 13			55,0	30	-	15	-	16	-	-	-	-	-	1,302
DG 1451 CKR 0605	C 05	38	45,0	40	45	7	23	8	7	4,5	-	-	-	2,220
DG 1451 CKR 0805	C 05	38	50,0	45	50	9	29	10	9	5,0	-	-	-	2,820
DG 1451 CKR 1005	C 05	38	50,0	55	60	11	35	12	11	8,5	-	-	-	1,760
DG 1451 CKR 1305	C 05	38	60,0	70	75	15	47	16	15	10,5	-	-	-	4,120
DG 1451 CKRS 0603	C 03	28	27,0	39	42	7	-	15	7	-	14	6	-	0,250
DG 1451 CKRS 0803	C 03	28	32,0	37	42	9	-	19	8	-	16	6	-	1,250
DG 1451 CKRS 1005	C 05	38	42,5	47	56	11	-	23	11	-	20	8	-	2,220
DG 1451 CKRS 1305	C 05	38	54,0	60	69	15	-	31	13	-	26	10	-	3,120



2 Teakfield Road, Springfield Park,  
Durban, South Africa

Tel: (+27) 31 579 9300  
Email: [admin@dems.co.za](mailto:admin@dems.co.za)  
Website: [www.dems.co.za](http://www.dems.co.za)



Osborn Park, Stark Road, Germiston,  
Johannesburg, South Africa

Tel: (+27) 11 824 0834  
Email: [admin@dems.co.za](mailto:admin@dems.co.za)  
Website: [www.dems.co.za](http://www.dems.co.za)



11 Falcon Crescent, Airport City,  
Cape Town, South Africa

Tel: (+27) 21 534 3388  
Email: [info@gartech.co.za](mailto:info@gartech.co.za)  
Website: [www.gartech.co.za](http://www.gartech.co.za)



## PROFILE KR/KRC/RR/RRC

## V- BELT AND POLYURETHANE CORD PROFILES

Ø Belt	Art. -No.	C-steel-No.	BC	B	H	HC	b	r	h	kg/m
<b>PROFILE KR</b>										
8	DG 1451 KR 008			20	10	-	6,0	-	3,5	0,165
10	DG 1451 KR 010			20	10	-	7,2	-	4,5	0,155
13	DG 1451 KR 013			20	12	-	9,2	-	6,0	0,162
17	DG 1451 KR 017			30	15	-	11,5	-	8,0	0,317
20	DG 1451 KR 020			30	20	-	13,5	-	9,0	0,424
22	DG 1451 KR 022			35	20	-	14,5	-	10,5	0,47
25	DG 1451 KR 025			40	25	-	16,5	-	12,0	0,701
32	DG 1451 KR 032			50	30	-	21,0	-	16,0	1,008
40	DG 1451 KR 040			60	35	-	26,0	-	21,0	1,395

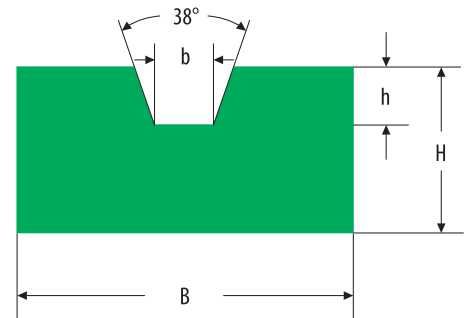

### PROFILE KRC

8	DG 1451 KRC 0802	C 02	20	20	10	15	6,0	-	3,5	0,135
10	DG 1451 KRC 1002	C 02	20	20	15	18	7,2	-	4,5	0,210
13	DG 1451 KRC 1303	C 03	28	25	18	22	9,2	-	6,0	0,324
17	DG 1451 KRC 1703	C 03	28	30	18	24	11,5	-	9,0	0,317
20	DG 1451 KRC 2003	C 03	28	30	18	24	13,5	-	9,0	0,292
22	DG 1451 KRC 2205	C 05	38	35	25	30	14,5	-	10,5	0,611
25	DG 1451 KRC 2505	C 05	38	40	25	32	16,5	-	12,0	0,611
32	DG 1451 KRC 3210	C 10	60	60	35	40	21,0	-	16,0	1,495
40	DG 1451 KRC 4010	C 10	60	60	35	40	26,0	-	21,0	1,200

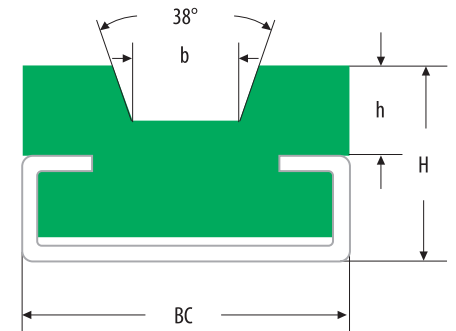

### PROFILE RR

5,0	DG 1451 RR 05			20	10	-	-	3	3	0,172
6,3	DG 1451 RR 06			20	10	-	-	4	4	0,165
8,0	DG 1451 RR 08			20	12	-	-	5	5	0,187
9,5	DG 1451 RR 10			25	15	-	-	6	6	0,297
12,5	DG 1451 RR 12			30	20	-	-	7	8	0,482
15,0	DG 1451 RR 15			35	25	-	-	9	10	0,704
18,0	DG 1451 RR 018			40	25	-	-	10	12	0,786

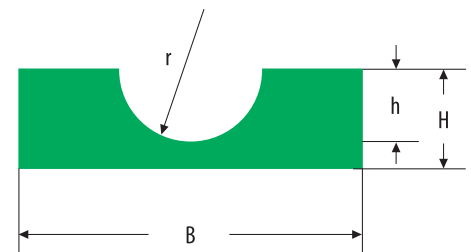

### PROFILE RRC

5,0	DG 1451 RRC 0502	C 02	20	20	10	15	-	3	3	0,145
6,3	DG 1451 RRC 0602	C 02	20	20	15	18	-	4	4	0,222
8,0	DG 1451 RRC 0802	C 02	20	20	15	18	-	5	5	0,145
9,5	DG 1451 RRC 1003	C 03	28	25	15	20	-	6	6	0,259
12,5	DG 1451 RRC 1203	C 03	28	28	15	20	-	7	8	0,264
15,0	DG 1451 RRC 1505	C 05	38	33	20	25	-	9	10	0,469
18,0	DG 1451 RRC 1805	C 05	38	38	20	25	-	10	12	0,452

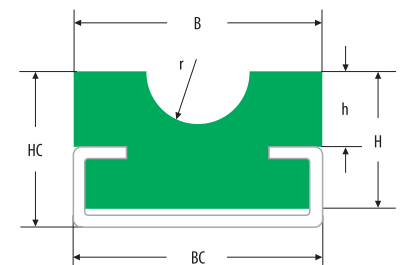

2 Teakfield Road, Springfield Park,  
Durban, South Africa

Tel: (+27) 31 579 9300  
Email: [admin@dems.co.za](mailto:admin@dems.co.za)  
Website: [www.dems.co.za](http://www.dems.co.za)



Osborn Park, Stark Road, Germiston,  
Johannesburg, South Africa

Tel: (+27) 11 824 0834  
Email: [admin@dems.co.za](mailto:admin@dems.co.za)  
Website: [www.dems.co.za](http://www.dems.co.za)



11 Falcon Crescent, Airport City,  
Cape Town, South Africa

Tel: (+27) 21 534 3388  
Email: [info@gartech.co.za](mailto:info@gartech.co.za)  
Website: [www.gartech.co.za](http://www.gartech.co.za)



2 Teakfield Road, Springfield Park,  
Durban, South Africa

Tel: (+27) 31 579 9300  
Email: [admin@dems.co.za](mailto:admin@dems.co.za)  
Website: [www.dems.co.za](http://www.dems.co.za)



Osborn Park, Stark Road, Germiston,  
Johannesburg, South Africa

Tel: (+27) 11 824 0834  
Email: [admin@dems.co.za](mailto:admin@dems.co.za)  
Website: [www.dems.co.za](http://www.dems.co.za)



11 Falcon Crescent, Airport City,  
Cape Town, South Africa

Tel: (+27) 21 534 3388  
Email: [info@gartech.co.za](mailto:info@gartech.co.za)  
Website: [www.gartech.co.za](http://www.gartech.co.za)